

MEMO

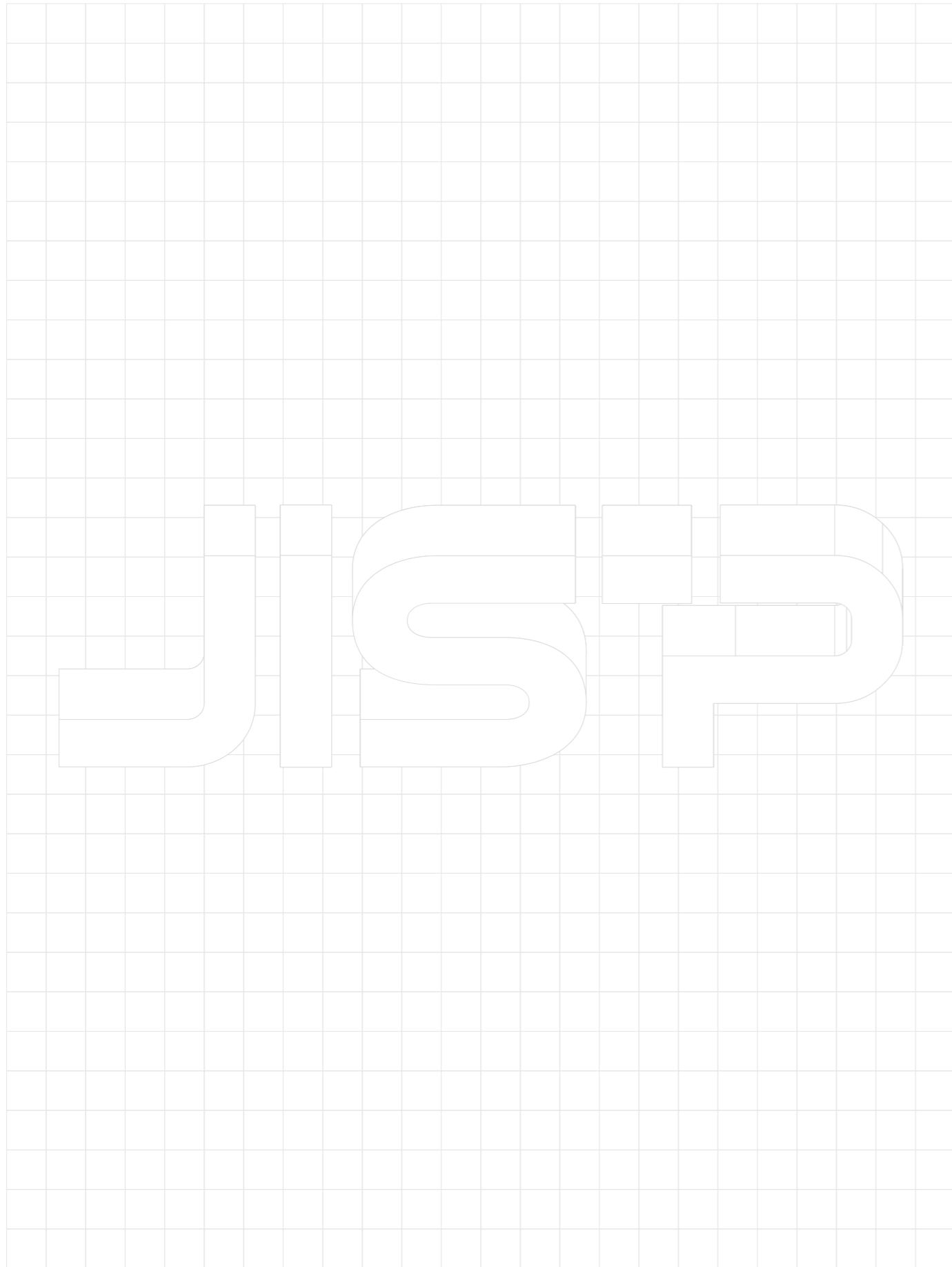

SPEED CONTROLLER 调速阀 Series

AIR SILENCER 消声器 Series

AIR HYDRO CONVERTER 气液转换器 Series

BOOSTER CYLINDER 增压缸 Series

CHAPTER 10 第10章



Speed Controller
调速阀



Metal Silencer
金属消声器



Plastic Silencer
塑料消声器



Air Hydro Converter
气液转换器



Direct Compressed Type
Booster Cylinder
直压型增压缸



Precompressed Type
Booster Cylinder
预压型增压缸

JSC Series

Speed Controller 调速阀

□ 1/8, 1/4

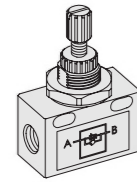

JSC02-1

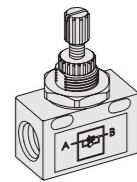

JSC02-2

SPECIFICATION 规格

ITEM 项目	FUNCTION 功能	SERIES 系列	
		1/8	1/4
Inside Pressure(bar)		15.0	
Pressure Range(bar) 压力范围		0.5~9.9	
Ambient & Fluid Temp. 环境及流体温度		5~60°C(41~140°F)	
Weight(g) 重量		80	
Flowing	Effective Profile Area mm ² 有效截面积	5	
Control	Flux(Nl/min) 流量	250	
Flowing	Effective Profile Area mm ² 有效截面积	3.7	

The Material of Parts 部件材质

Valve Body : Zinc Pressure Die-Cast	阀体 : 压铸锌
Housing : Brass	外罩 : 铜
Control Bar : Brass	调板 : 铜
Hex Nut : Carbon Iron	六角螺母 : 碳钢
Lock Nut : Brass	锁母 : 铜
Seals : NBR	密封 : NBR



JISP

Speed Controller 调速阀 Thread- 1/8 接口: 1/8

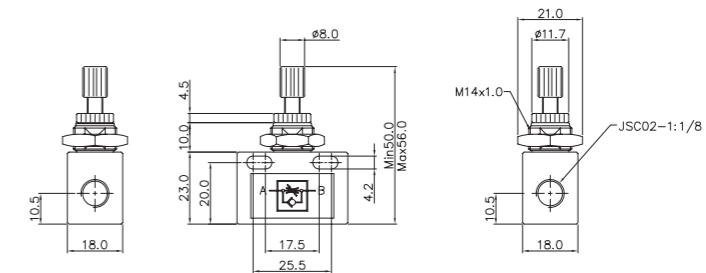

Speed Controller 调速阀 Thread- 1/4 接口: 1/4

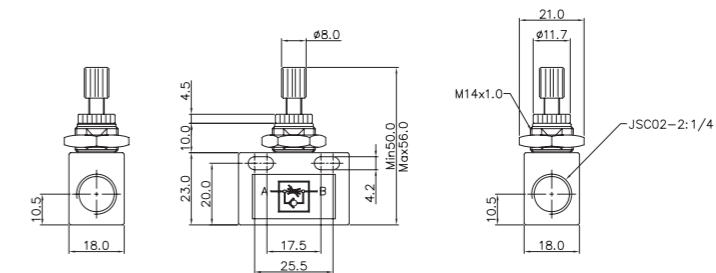

ORDERING CODE 订购代号

JSC 02 - 1

Model 型号	Port Size & Thread 接口螺纹
JSC 02	1 G 1/8
	2 G 1/4
	3 NPT 1/8
	4 NPT 1/4

PANEL HOLE 面板安装孔

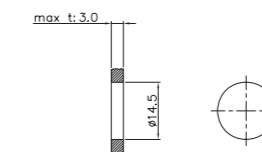

SILENCER Series

消声器系列

□ M5, PT1/8, 1/4, 3/8, 1/2

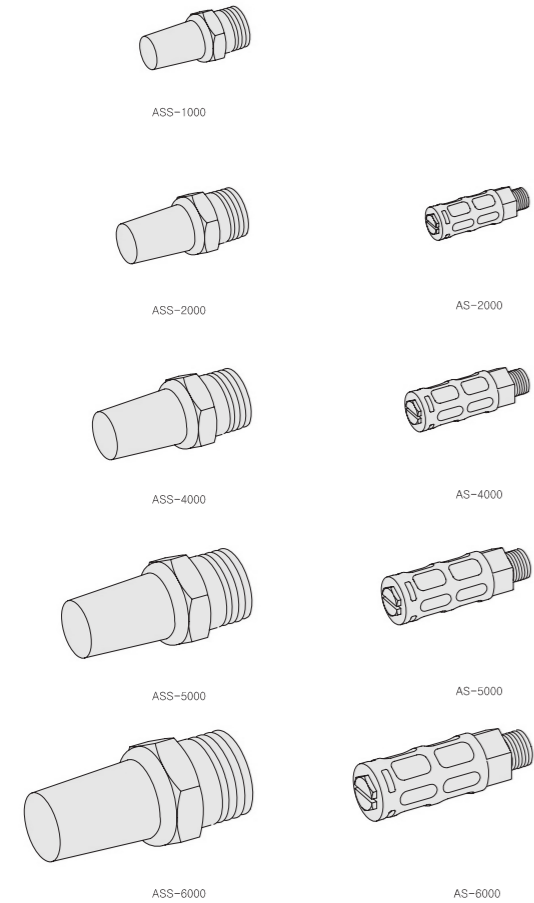

SPECIFICATION 规格

METAL SILENCER 金属消声器

Type 型号	PORT SIZE 接口	WEIGHT 重量 (g)	DIAMETER 尺寸			
	PT		A	B	C	D
JASS 1000	M5	2	4	18	7	7
JASS 2000	1/8	6	7	24	8	11
JASS 4000	1/4	17	8	32	10.5	15
JASS 5000	3/8	28	10	39	12	19
JASS 6000	1/2	35	14	44	15	22

PLASTIC SILENCER 塑料消声器

Type 型号	PORT SIZE 接口	WEIGHT 重量 (g)	DIAMETER 尺寸			
	PT		A	B	C	D
JAS 2000	1/8	5	40	16	14	7
JAS 4000	1/4	14	65	21	20	10
JAS 5000	3/8	22	85	25	22	13
JAS 6000	1/2	32	95	26	26	14

The Material of Parts 部件材质

Metal Silencer 金属消声器
• Body : Copper 本体 : 铜

Plastic Silencer 塑料消声器
• Body,Cap : POM 本体 : POM

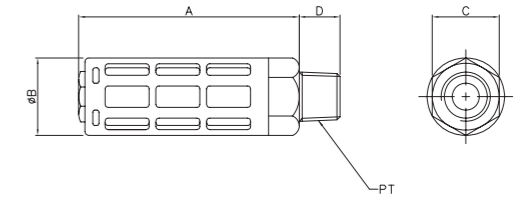
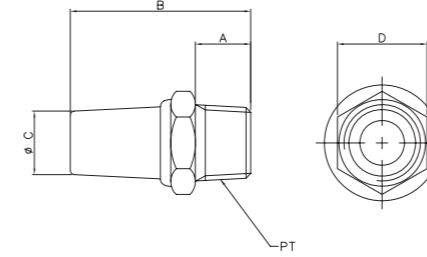
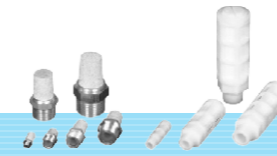

MODEL NO. 型号	PORT SIZE 接口 PT	WEIGHT 重量 (g)	DIAMETER 尺寸			
			A	B	C	D
JASS 1000	M5	2	4	18	7	7
JASS 2000	1/8	6	7	24	8	11
JASS 4000	1/4	17	8	32	10.5	15
JASS 5000	3/8	28	10	39	12	19
JASS 6000	1/2	35	14	44	15	22

MODEL NO. 型号	PORT SIZE 接口 PT	WEIGHT 重量 (g)	DIAMETER 尺寸			
			A	φB	C	D
JAS 2000	1/8	5	40	16	14	7
JAS 4000	1/4	14	65	21	20	10
JAS 5000	3/8	22	85	25	22	13
JAS 6000	1/2	32	95	26	26	14

ORDERING CODE 订购代号

JASS - 1000

Silencer Type 类型
JASS: Metal Silencer 金属消声器
JAS: Plastic Silencer 塑料消声器

Connection Size 接口尺寸
1000 M5 x 0.8
2000 PT 1/8
3000 PT 1/4
4000 PT 3/8
5000 PT 1/2